

2025



Innovative Fishing Products

CRALUSSO,  
CHOICE OF THE WINNERS

[www.cralusso.com](http://www.cralusso.com)





Based on the recognition of his innovative work, Károly Králik, the CEO of Cralusso, was elected as the Hungarian Talent Ambassador.

When I decided to launch Cralusso I knew that instead of improving on existing products I would have to set off in an entirely new direction, developing new solutions and technologies. Our revolutionary innovations, such as our ground-breaking fishing floats enabled users to win countless world, European and national championships. During the recent years and months we have been focusing on reforming feeder and method equipment. Our unrivalled models were developed with the help of cutting-edge 3D printing technology. Which were chosen as Europe's best new product in four categories and awarded with the EFTTEX award.

### Cralusso, choice of the winners



With our individual developments, our users have won numerous world, European and national titles! Try these products that can make you successful too.

### Significant results with our products.

- 2002: Launch Cralusso
- 2003: World Championship – Torpedo
- 2005: European Championship – Torpedo
- 2006: Innovation Expo, GENIUS award
- 2007: U.S. Open – Golf and Bubble
- 2008: European Championship – Torpedo
- 2008: U.S. Open – Shark
- 2008: Hungarian National Championship – Shark
- 2009: Best Stand award
- 2010: Sponsorship at Poznan World Cup
- 2012: Title of Hungarian Talent Ambassador
- 2013: Expand the NAVIGATOR line
- 2014: Dutch men's team – the title of world champion  
Hungarian team of disabled people – individual and team title of world champion  
Hungarian team of veterans – world champion bronze medal

- 2015: Best Stand award  
Slovakian Team won the Club Team World Championship with Torpedo floats
- 2018: Our company has won a research and development tender. We have established our development workshop equipped with state-of-the-art machines to provide a foundation for the innovations in the coming years.
- 2019: The Bosnian team that won club world championship using our Raj and Torpedo floats in Prelog, Croatia.
- 2022: Our innovative developments has earned EFTTEX awards.
- 2023: Our Big Rocket and Jelly Snail products became the best product in their category at EFTTEX. The European Championship has won with our Arrow waggler float!
- 2024: József Papp won the Individual World Championship in the veteran category using our Helio waggler float.



# Award-winning innovative products



Terminal tackle category winner  
Individual Big Rocket  
method baskets



Hookbait category winner  
ECO friendly, decomposable,  
Jelly baits, derived from  
food materials



## Pro Carbon

Accessory category winner  
Pro Carbon waggler floats



Fishing lines category winner  
The Innovative, marked fishing lines  
called Navigator



Carp and Feeder  
category winner  
The Slow Sinking  
method basket.



Hookbait category winner  
The Jelly leech catfish bait.





A new hydrodynamic form developed by Cralusso, the body does not lift out the water when held back. This float is for use on the pole and is ideal for use in medium or strong flow when you wish to present static or slow moving baits. It is so good and reliable that it has become the number one choice of flat float for anglers of all abilities including a few world champions!

Some quotations about the Torpedo:

- **Alan Scotthorne:** "The best flat float I've ever used"  
*Angling Times, May 10 2005.*
- **Bob Nudd:** "It will add a new dimension to your polefishing"  
*Angling Times 31 May 2005*

Sizes:  
0.5 - 0.75 - 1.0 - 1.5 - 2.0 - 3.0 - 4.0 - 5.0 gr

PUR



Code: 1001

## TORPEDO Tuning

An advanced version of the Torpedo float, which helped the Hungarian team to win gold in the 2003 World Championship. The Torpedo Tuning was also the success story of the 2005 European Championship - 80% of the contestants used our floats, including Will Raison, the individual champion.



PUR

As with the Torpedo, this float is for use on the pole and is ideal for use in medium or strong flow when you wish to present static or slow moving baits.

Sizes: 6 - 8 - 10 - 12 - 15 - 20 - 25 - 30 - 40 - 50 - 70 gr

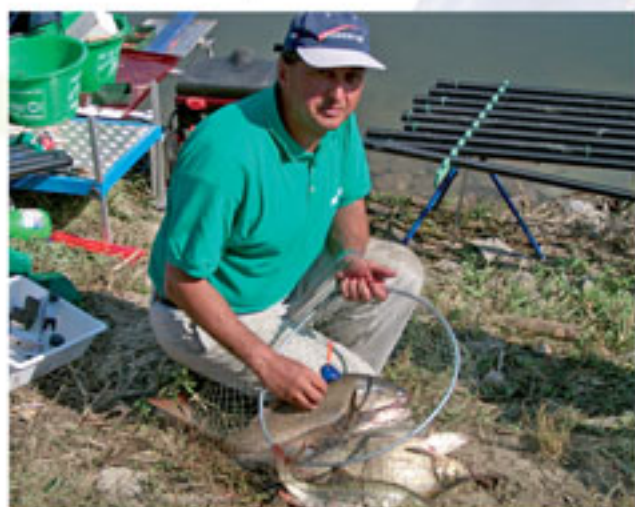

With recommendation of Tibor Ambrus, world champion

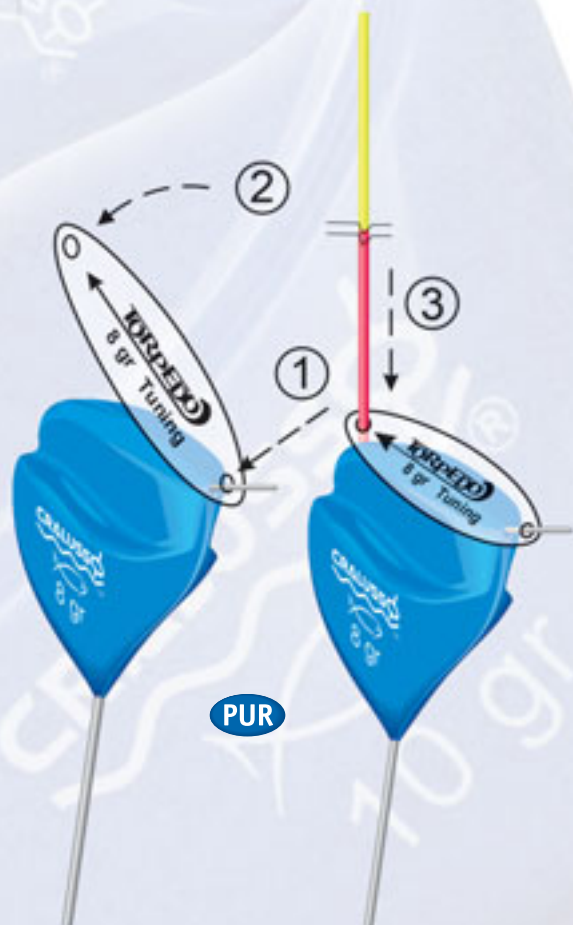

PUR

3  
Year  
Guarantee



# Bubble



Code: 1003

A river float designed for use on the pole but has found favour with many anglers on the running line. It is ideal for running through the swim at variable speed. The Bubble was introduced in 2005 Madunice European Championship.

**The winner of U.S. Open in 2007 and 2008!**

Variable antenna 1-5 gr 2 pcs  
Variable antenna 6-20 gr 5 pcs  
Waterproof polyurethane body  
Floats can be changed without dismantling the rig

Sizes:

1 - 1,5 - 2 - 3 - 4 - 5 - 6 - 8 - 10 - 12 - 15 - 20 gr  
30 - 40 - 50 gr



The next step of success!  
József Papp won the 2008 U.S. open using  
a Cralusso Bubble

# SHARK

## Functions of two floats in one 2 in 1

Code: 1004

1  
Year  
Guarantee

- 1 You should use the first antenna position when you are holding the float back hard or even lightly.
- 2 You should use the second antenna position when you want the float running through the swim

Sizes:

1 - 1,5 - 2 - 3 - 4 - 5 - 6  
8 - 10 - 12 - 15 - 20 gr  
25 - 30 - 40 - 50 gr

Shark, the brand new flat float was developed using many years of experience in float design and was in response to the demand from professional anglers. Used primarily for pole fishing the float can present baits in many ways. The antenna position can be changed according to your technique – whether this is holding back hard or running the float through the swim.

When the current is strong or you are holding back hard use the first bristle position. When the flow is slower or you want to run the float through the swim the second bristle position is recommended.

The streamline hump on top of the float – the sharks fin – aids stability and sensitivity – even the smallest of bites can be seen clearly.

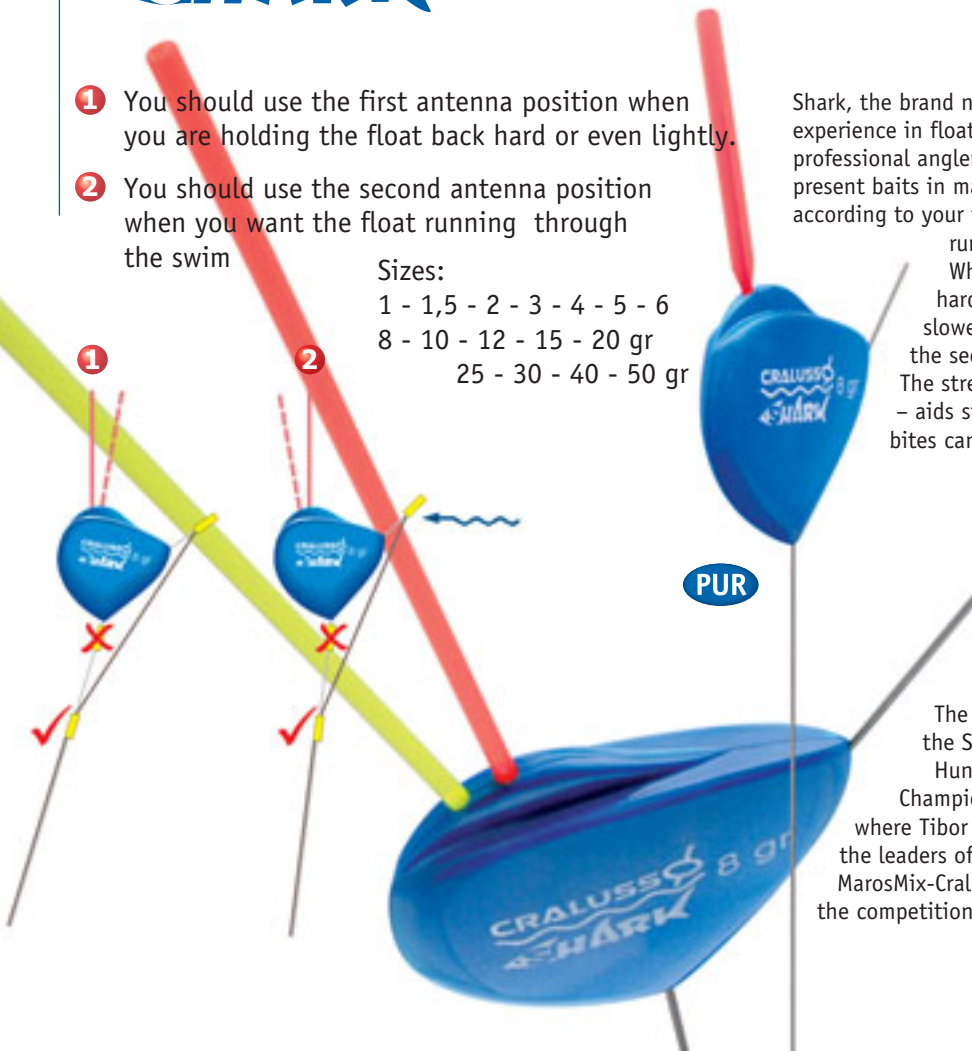

The introduction of the Shark was at the Hungarian National Championship in 2008, where Tibor Ambrus, one of the leaders of the Tubertini-MarosMix-Cralusso group won the competition using this new float.





## Choice of the Champions

Code: 1027

This hard-wearing polyurethane disc float developed by Cralusso can take the place of traditional balsa models, that can be damaged easily.



Sizes:  
1 - 1,5 - 2 - 3 - 4 - 5 - 6 - 8 - 10 - 12 - 15 - 20 gr  
25 - 30 - 40 - 50 gr

The favourite float of the world championship held in Croatia in 2014, helping the Dutch team to earn the title of world champion



In this competition, Alan Scotthorne – five times individual world champion of England – and many other teams have used the innovative Cralusso floats!

# Surf

Code: 1002

A special river float for use with rod and reel set ups that can be held back hard without drifting in across the flow. The direction and speed can be changed easily offering perfect and accurate presentation. Ideal for medium and strongly currents although it can be used on still water for predator fishing when you wish to work a baitfish parallel to the bank.



Sizes:  
3 - 4 - 6 - 8 - 10 - 12 - 15 - 20 gr

# Bolo

Code: 1005

Sizes:  
3 - 4 - 6 - 8 - 10 - 12  
15 - 20 gr

A river float for use Bolognese rods and any running line set up. The design allows you to hold the float back without it drifting in across the flow. You can vary the speed of travel easily, but in sufficient flow and by holding back hard it is possible to lead the Bolo out from the bank toward features, cover or your feed line. You can effectively position the float before letting it run through the swim.





Code: 1007

The Ufo and Dart floats utilize Cralusso's innovations, which give them their efficacy and popularity.

- 1
- 2
- 3
- 4

Adjusting the antenna and the sensitivity can be performed repeatedly using the calibration solution. They've become preferred by the anglers because of their versatile, simple usage and their durable design.

The concept is the same as that found in the UFO waggler but in addition to the other latest developments this version incorporates a flight.

- 1
- 2
- 3
- 4

The body is made of polyurethane, which is not sensitive to surface damage. The Dart is a very versatile float, which is a suitable for both pleasure and match anglers alike.

The aerodynamics are improved with surface indentations (as on a golf ball) which reduces air resistance and increases stability.



Recommended float adaptors  
 Waggler Attachment Light: 2005  
 Brass Head Safety Snap: 2122  
 Plastic head swivel with interlock snap: 2123

# DART

Code: 1008

1

← Thanks to the versatile and adaptable antenna system, twenty Cralusso sight tips can be used with this float. Three tips are contained in each pack.

2

← The stem of the float is made from a material that is very strong and will remain straight without becoming twisted or curved.

3

← The calibration system helps quick, simple and accurate adjustments, with 0,05 gr graduations being possible

PUR

4

→ The removable dart wings help the floats to the flight.

Size gr	Changeable weight
6	2,5 gr
8	3,0 gr
10	3,0 gr
12	3,0 gr
14	3,5 gr
16	3,5 gr
18	4,5 gr
20	5,5 gr



# Sensitive

Code: 1010



Sizes: 5 - 7 - 9 - 11 gr

Variable antenna 2 pcs

Type	Distance of Casting	Changeable weight
<b>Pro Carbon</b> 8-16 gr	35-60 m	1,0-5,0 gr
<b>Rocket</b> 6-20 gr	40-85 m	2,0-3,5 gr
<b>Helio</b> 8-30 gr	40-75 m	2,5-15 gr
<b>Dart</b> 6-20 gr	35-65 m	2,5-5,5 gr
<b>Sensitive</b> 5-11 gr	35-55 m	1,5-3,0 gr
<b>Ufo</b> 6-20 gr	30-50 m	2,5-5,5 gr





# proCarbon

## Waggler

Code: 1084

Professional waggler float, offering unique solutions for competitive and hobby angling as well. The float has a tapered carbon stem, a polyurethane body and tungsten discs.

A rotary part with a bearing is built into the lead head, which brakes, bends when it falls. The calibration solution developed by Cralusso allows for the quickest and most sensitive antenna setting to adjust with as little as 0.01 gramm. 1 year warranty!

Size gr	Changeable weight
8	1 gr
10	2 gr
12	3 gr
14	4 gr
16	5 gr

PUR

Strengthened pillow swivel built-in the lead head



The new combination of lead and tungsten weight discs has a high specific gravity and is therefore only half the volume of brass.

# WolframMatch

Code: 1085

We have been ecstatic over the success of the Arrow waggler but we never rest and have achieved even further improvement for this year. In addition to the already successful developments

1 2 3 4

we are now using a weight system that is twice as heavy as brass.

This lead/tungsten combination disc system together with the new aerodynamically refined body has created an even better flight, operation and precision in use.

The antenna system consists of over 20 versions with varying diameters, lengths and colours available. New to this range are the 'air antenna' - a clever highly visible tube and a very sensitive solid option.

Size gr	Changeable weight
8	2,5 gr
10	4,5 gr
12	6,5 gr
14	8,5 gr
16	10,5 gr
18	8,0 gr
20	10,0 gr

**Tip:** With the help of the unique calibration system you can speed up the float setting process and also achieve very precise setting of the antenna.

Strengthened pillow swivel built-in the lead head



New antenna with helium



Code: 1087

Professional waggler float with calibration system, new body shape, made using tungsten & helium!

Code: 1086

Our newest innovation, the HELIO waggler float incorporates the best of our knowledge. We used materials with the most optimal density, this means that the lead head, the tungsten discs and the helium-filled float body and shank provided the possibility to build an ideal float, which

- has the best flying capabilities;
- can be set to the highest sensitivity
- can be weighted in the shortest time
- has a stem that does not bend even on higher temperatures
- resists damage
- can hold over 30 types of antennas

Size gr	Changeable weight
8	2,5 gr
10	4,5 gr
12	6,5 gr
14	8,5 gr
16	10,5 gr
18	8,5 gr
20	10,5 gr
25	10,0 gr
30	15,0 gr

Lead - tungsten combined weight system

The new combination of lead and tungsten weight discs has a high specific gravity and is therefore only half the volume of brass.

Heeding the requests of the anglers, we added to our offer this easy to use, easy to throw Slider float, which satisfies the highest demands of the hobby and sport anglers. The 3.0 gr net weight of the special slider head and the design of the PUR body give excellent flying capabilities to the float. It is mainly recommended for deep water and lakes with strong currents, when the bait needs to be sunken to the vicinity of the lakebed quickly and in a stable way.

- Simple, precise usage
- Fastest antenna and sensitivity adjustment with the help of the calibration system.
- Versatile variability for weighting
- Replaceable solid and air-filled antennas

Sizes
3 + 8,0 gr
3 + 10,0 gr
3 + 12,0 gr
3 + 14,0 gr
3 + 16,0 gr
3 + 18,0 gr

**Tip:** The new waggler stem set (Item: 2034), increase the capacity and variability of the float. The different length of stems (250-330), can be accelerate the balance, furthermore increase the distance of flight.

Sizes: 8-10-12-14-16-18 gr

Attention! The calibration stem shouldn't be extended further than the red mark!

PUR

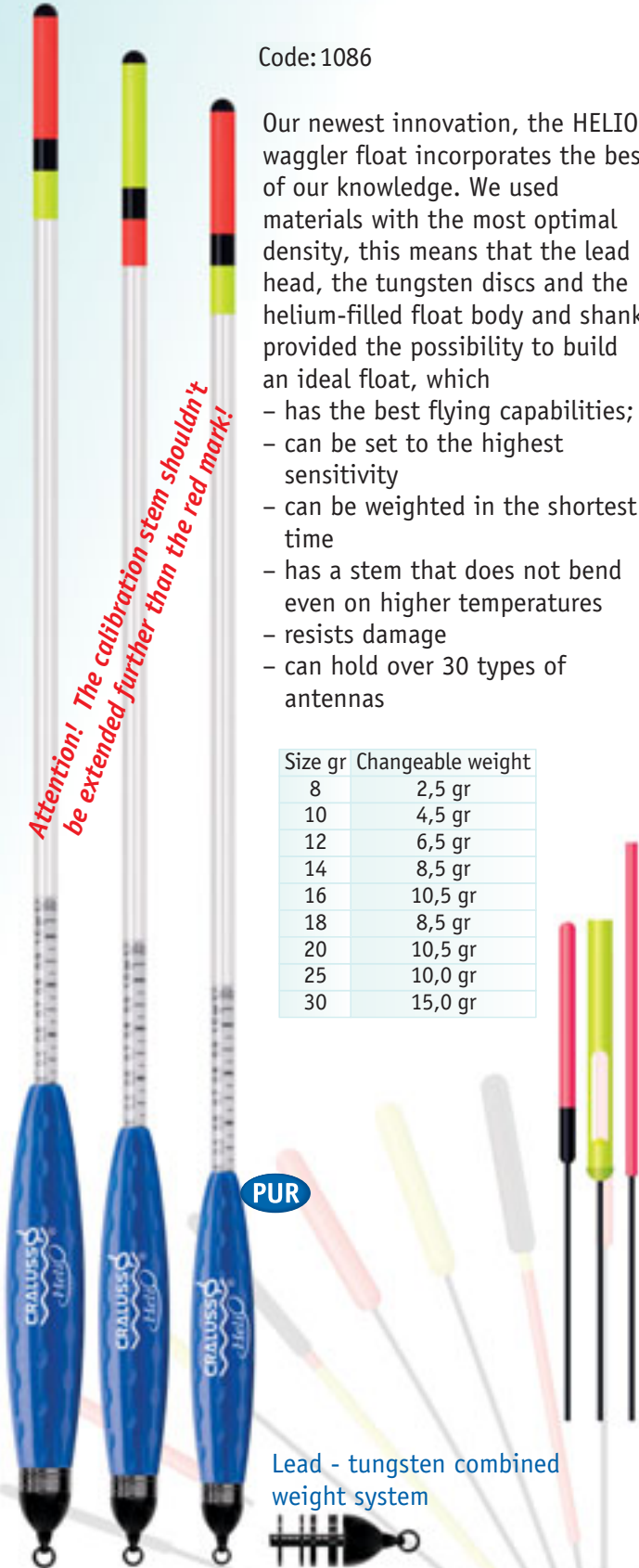



# The aim of continuous innovation to create the best waggler float!

## ARROW waggler

Code: 1040

Incorporates a removable brass disc weight system and, of course, all the usual Cralusso innovative features

- 1 2 3 4

The ARROW waggler ensures an aerodynamic flight, high levels of sensitivity and offers a multifunctional, easy to use float. The longer stem offers the following advantages:

- Generates extraordinary stability and distance in flight
- The body and main weight of the float sits deep in the water and it is therefore less influenced by wind and surface skim
- The long float aids the important task of getting your line deep in the water

Transportation of the long float is not difficult as the stem and body can be separated. This allows the carrying of made up rods where required with no risk of float damage.

Size gr	Changeable weight
8	3,0 gr
10	4,0 gr
12	5,0 gr
14	6,0 gr
16	7,0 gr
18	8,5 gr

PUR



## BREAM FLOAT

Code: 1082

Size gr	Changeable weight
6	1,5 gr
8	2,5 gr
10	3,0 gr
12	4,0 gr
14	5,0 gr
16	6,0 gr



By sliding the tube to calibrate the float you can minutely adjust the weighting.

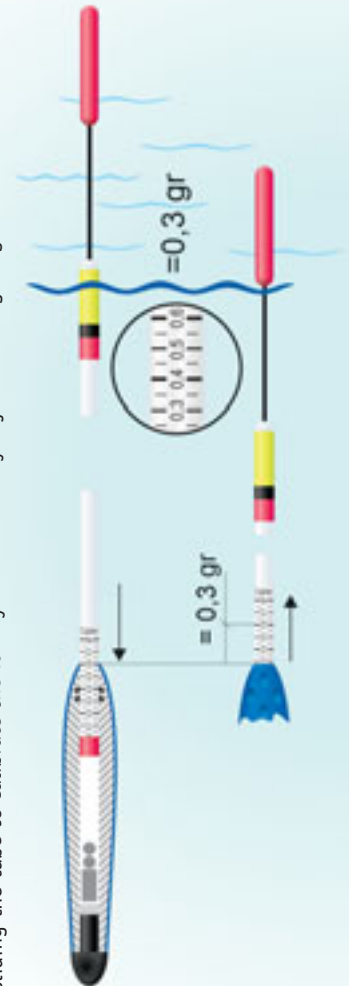

Strengthened pillow swivel built-in the lead head





## Multicolor waggler

Code: 1013

Size gr	Changeable weight
8	2 gr
10	2 gr
12	2 gr
14	2 gr



## Unweighted slider floats

Code: 1029

Sizes:  
3-4-5-6-8 gr





## CONTROL MATCH

Code: 1023

Cralusso's newest development is a perfect solution for the problems of many anglers. We have used the very popular calibration system from our bodied wagglers and have also managed to incorporate this system into our revolutionary new straight wagglers. The slim body creates a very sensitive float and the calibration system makes very fast and accurate adjustment possible.

## CONTROL MATCH

with dart

Code: 1024

The construction of this float is the same as the "Control Match", but we incorporated dart flights into the stem to allow even better flight. The antenna are inter-changeable.

Sizes:

You can adjust the 3-4-5 gr float's loading capacity between 0 and +1,2 gr.

You can adjust the 6-7-8-10 gr float's loading capacity between 0 and +1,5 gr



## PRO MATCH

Code: 1025

"Pro Match" floats contain all the useful developments that make the 'Control' version unique. As we have used brass removable heads, it is possible for finer adjustments to be made and for the carrying capacity to be increased still further. It is possible to make very quick, accurate and repeated adjustments by pushing in, or pulling out, the upper, thinner stem from the body of the float.

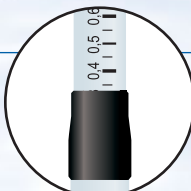

By sliding the tube to calibrate the float you can minutely adjust the weighting.

## PRO MATCH with dart

Code: 1026



The adjustable capacity of the 4 gr float is: between 0 and +2,5 gr  
 The 5 gr and 6 gr float is: between 0 and +3,0 gr  
 The 7 gr and 8 gr float is: between 0 and +3,5 gr



# New Carp floats

Code: 1090

Unweighted carp floats with PUR body

Code: 1095

Carp floats with fix weight

Heavy-duty fishing floats with pur body, developed to carp fishing



# Winner of US Open Championships in 2007



When we were creating the traditional type of tear drop floats it was our intention, as is always the company policy, to place the emphasis on making each model easy to use, infinitely variable and long lasting. The design allows all of the components, including the bristles, to be freely interchanged thus allowing numerous combinations to be achieved. The floats are available a near transparent fibre glass stem that is less visible in water.

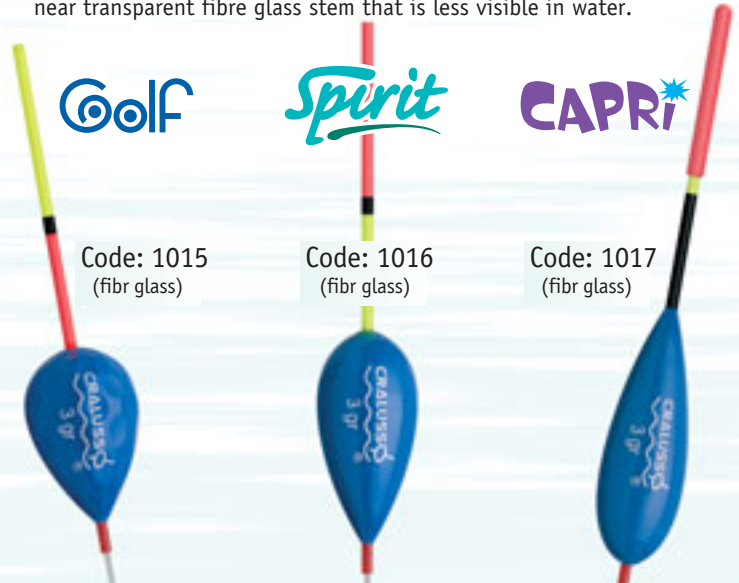

The special dimpled surface of this Golf float, which reduces water tension affects, makes it an ideal choice for use on rivers, moving canals and choppy lakes.

Sizes:  
1 - 1.5 - 2 - 3 - 4  
5 - 6 - 8

Universal shape which is ideal for both rivers and still waters. The protective plastic tube through the float is very hard wearing and makes the float virtually indestructible highly recommended when fishing for carp on the pole.

Sizes:  
0,5 - 0,75 - 1  
1.5 - 2 - 3 - 4 - 5 - 6

This body shape allows for more sensitive presentation even more so if you use the 1 mm carbon or glass stem as the bristle.

Also incredibly strong, however, and will handle big fish well.

Sizes:  
0,2 - 0,3 - 0,5 - 0,75 - 1  
1.5 - 2 - 3 - 4 - 5 - 6

They are well constructed and very strong. Bristles are interchangeable so you can make rigs that perform well for delicate presentation or dealing with big weights of fish.

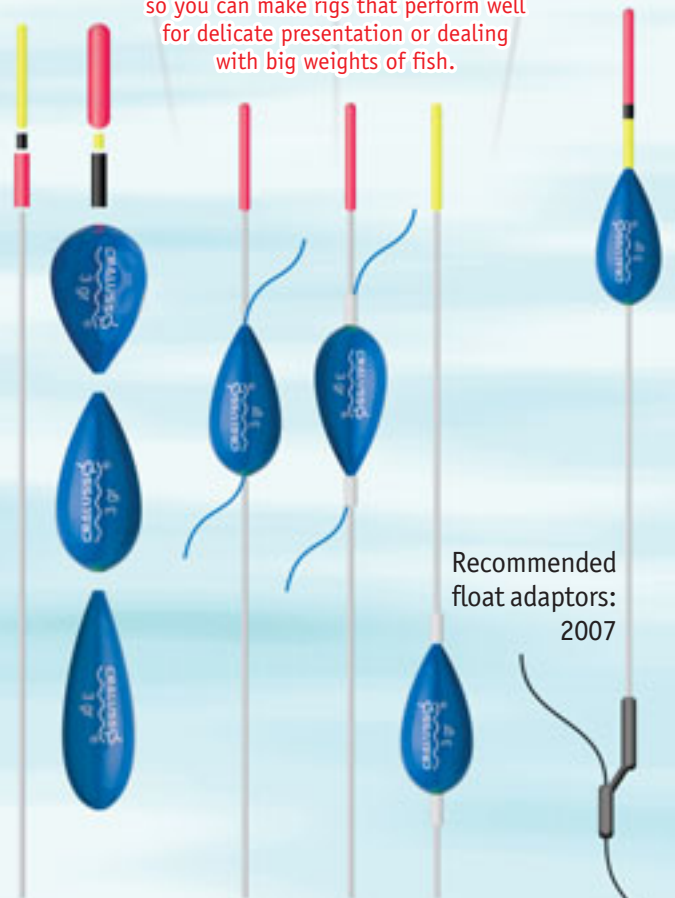

Recommended float adaptors: 2007



## Carp Series

## Float with balsa antenna

1073



Code	Weight gr	Antenna	Stem	Body mat.	Pcs/bag
1073	0,4-0,6-0,8	fix	carbon	balsa	5



Code	Weight gr	Antenna	Stem	Body mat.	Pcs/bag
1060	1-2-3-4-5-6	balsa	fibre glass	balsa	5
1061	0,2-0,4-0,6-0,8 1-1,5-2-3-4-5	balsa	fibre glass	balsa	5
1063	0,5-1	balsa	fibre glass	balsa	5

## Float with balsa



Code	Weight gr	Antenna	Stem	Body mat.	Pcs/bag
1041	1-1,5-2-3-4-5	plastic	fibre glass	balsa	5
1044	0,5-1-1,5	fibre glass	carbon	balsa	5
1045	0,4-0,5-0,75-0,8 1-1,25-1,5-2	hollow	carbon	balsa	5
1046	0,8-1-1,5-2	hollow	carbon	balsa	5
1047	0,6-0,8-1-1,5	fibre glass	carbon	balsa	5
1048	0,4-0,8-1-1,25	fibre glass	carbon	balsa	5

## Balsa float with changeable star light antenna

BALSA



Code	Weight gr	Antenna	Stem	Body mat.	Pcs/bag
1205	2-3-4-5-6-8-10	plastic	fibre glass	balsa	5
1206	1-2-2,5-3-4-5-6-8	plastic	fibre glass	balsa	5
1207	1-2-3-4-5-6	plastic	fibre glass	balsa	5
1208	2-3-4-5	plastic	fibre glass	balsa	5



# Attachments

2000  
Helium-filled antenna set  
(6 pcs/bag)



2001  
Mixed antenna set  
(10 pcs/bag)



It can be used for both Cralusso Wagglers and polyurethane tear drop floats.

2002  
Dart antenna set  
(3 pcs/bag)



High visibility hollow antenna that aids float flight. 0,6 gr sensitivity

2003  
Hollow antenna set  
(6 pcs/bag)

Sensitive, highly visible hollow antenna with 0,3 gr sensitivity



2011  
Universal star light holder  
4,5 mm-es  
(3 pcs/bag)



2034  
(5 pcs/bag)

2004  
Wagglers float stem range  
(3 pcs/bag)

2010  
DIY floats  
(8 pcs/bag)

2013  
Carbon and glass stem  
8 pcs 0,8 and 1,0 mm



Wagglers stem set • Length: 250-270-290-310-330 mm

2018  
Dart wings (9 pcs/bag)



2019  
Flat antennas  
(9 pcs/bag)

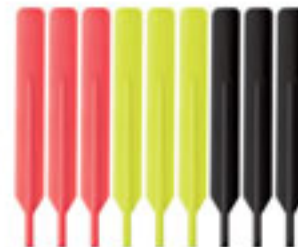

## Wagglers attachment Light

(Fixed)

Code:2005

A sure and safe float fixing that allows quick changes. Tangles and knots are reduced because of the built in big load bearing swivel. The attachment is very light as carbon is used in the manufacture. We offer the small Wagglers attachment for 8-10 gr floats, and the medium attachment for floats above 10 gr.

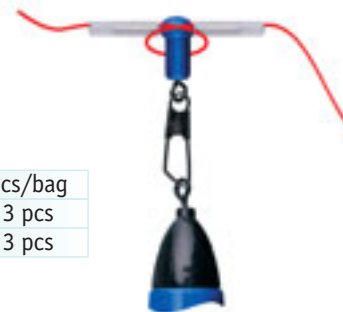

Size	Code	Weight	Pcs/bag
Small	2005	0,22 gr	3 pcs
Medium	2005	0,35 gr	3 pcs

## Anti tangle wagglers attachment

(Fixed)

Code:2006

Cralusso's own development! The success of the anti-tangle wagglers attachment lies in the asymmetric design which allows the device to keep the line away from the float and so greatly reduce the possibility of tangles and knots.

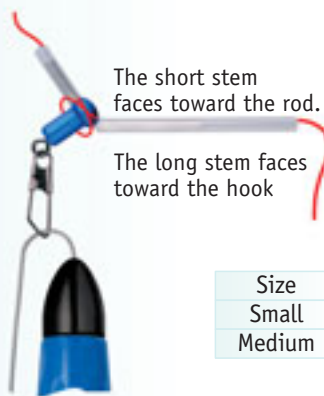

The short stem faces toward the rod.

The long stem faces toward the hook

How to use this attachment?

Size	Code	Weight	Pcs/bag
Small	2006	0,30 gr	3 pcs
Medium	2006	0,45 gr	3 pcs

## Metal wagglers snap

Code:2035

Float fixer with ball bearing swivel, withstands the highest loads



Weight	Pcs/bag
0,30 gr	2 db



Adjustable float-holding roll

2032 S

2032 M



Adjustable roll-length

Antibacterial spray

2059



Line's sinking spray

2058



Line marker

2054



2055



2056



2057



Colour antenna label

2050





Strong silicon tubes 2009  
0,8x2,2 mm



Silicon tubes mixed  
2009-mix

Olive rubber stopper  
2008

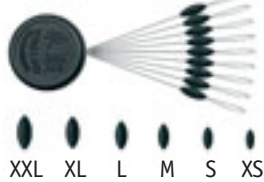

Size	Pcs/bag
XS	9 pcs
S	9 pcs
M	9 pcs
L	9 pcs
XL	9 pcs
XXL	9 pcs
mix	3x9 pcs

Size	Weight	Pcs/bag
0,5 mm	0,1 gr	4 pcs
0,7 mm	0,1 gr	4 pcs
0,9 mm	0,1 gr	4 pcs

Cylindrical rubber  
stopper  
2016

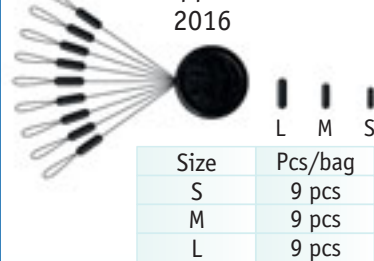

Size	Pcs/bag
S	9 pcs
M	9 pcs
L	9 pcs

Float adaptors  
For tear drop floats  
2007



Float fixing set  
2014-mix



Pellet ring 2015  
Sizes: S-M-L



Anti-tangle soft tube 2017  
0,5x1,8-0,8x1,9-1,0x2,1 mm



Bait holder 2025  
Sizes: S-L



Flare rubber thorn  
2012-mix



Pellet stopper kit  
2026 Hard



Metal bait spike 7-10 mm  
2028 S 7 mm, M 10 mm



Plastic bait spike 2029  
S 5-7 mm, M 10-13 mm



Boilie stopper  
2027



Silicon fastened bait sting  
2030  
S 7mm - M 10mm

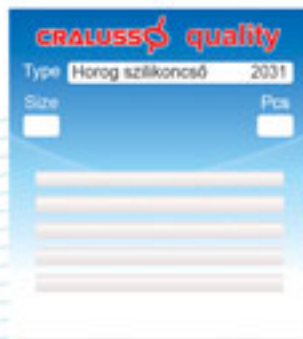

Hook Silicone Tube 2031  
0,3 and 0,5 mm



Fine bait spike 2051  
S 7 mm - M 10 mm



## Cralusso lines = Cralusso quality!

“PRESTIGE” fishing line – as the name implies, this range will satisfy the highest demands of the modern angler. We believe different disciplines of fishing require a line specifically designed for the purpose and that each must possess the correct properties for its intended use. As such, we have developed and tested the lines over a period of some years and are certain we are now offering a selection of the very best available at a truly competitive price.

### Hooklength Line *Soft & Strong*

2061



Great attention to detail has been paid to ensure this line has the optimal relationship between strength and suppleness. It is reliable, strong and resistant to twist and tangles.

Length (m)	Diameter (mm)	Breaking Strain (kg)
50	0,088	1,18
50	0,102	1,57
50	0,123	2,34
50	0,143	3,07
50	0,160	3,84
50	0,178	4,61
50	0,201	5,71
50	0,220	6,65
50	0,250	8,30

### feeder hooklength line

2085



New generation hooklength line, which developed for the feeder fishing, this line has more stiff and stretch.

Length (m)	Diameter (mm)	Breaking Strain (kg)
50	0,14	2,94
50	0,16	3,65
50	0,18	4,00
50	0,20	5,41
50	0,22	6,22

### Brutal

2069



As its name suggests this is a hooklength line with unique strength, what is nearly invisible in the water. Made by the most modern technologies and materials. It is extremely resistant to twist and tangles.

Length (m)	Diameter (mm)	Breaking Strain (kg)
50	0,102	1,65
50	0,125	2,42
50	0,145	3,18
50	0,163	3,98
50	0,183	4,77
50	0,202	5,93
50	0,22	6,80
50	0,25	8,45

Cralusso lines = Cralusso quality!

# **X**TREME braid hooklength line

2080



This braid hooklength made of the latest technology, weaving with 8 carriers, which ensure the cyclic cross-section. Due to this technology and PE fiber are ensure the precize and maximum tensile for the lines.

Length (m)	Diameter (mm)	Breaking Strain (kg)
15	0,08	3,8
15	0,10	5,1
15	0,12	6,3
15	0,14	7,6
15	0,16	9,5

# **KEVLINE** braid hooklength line

2081



This special angling line is made from 50% Kevlar and 50% PE fibre. Sinking design, which resists damage remarkably well, and allows use under extreme conditions.

Length (m)	Breaking Strain (kg)	Breaking Strain (lb)
10	6,8	15
10	9,1	20
10	11,3	25

# **Feeder & Carp** braid hooklength line

2082



This sinking braided line concentrically woven from 8 fibres has been developed to suit the needs of Feeder and Carp anglers. Thanks to its soft and strong design it can be a reliable and favoured equipment for anglers.

Length (m)	Breaking Strain (kg)	Breaking Strain (lb)
10	4,5	10
10	6,8	15
10	9,1	20

# **FAST SINKING** braid hooklength line

2083



We focused entirely on making this angling line sink fast, nestle to the watercourse, to be undetectable by the fish and stay at the bottom.

Length (m)	Breaking Strain (kg)	Breaking Strain (lb)
10	5,4	12
10	8,1	18
10	11,3	25





**GENERAL Match**

2060



A very reliable line with high tensile strength Excellent UV and abrasion resistance with silky smooth surface Specially recommended for general use and rig making

Length (m)	Diameter (mm)	Breaking Strain (kg)
150	0,12	2,24
150	0,14	2,75
150	0,16	3,46
150	0,18	4,14
150	0,20	5,12
150	0,22	6,54
150	0,25	8,19
150	0,30	11,22
150	0,35	15,49



**Match Sinking**

2062



This new generation sinking line has been developed specifically for waggler fishing. It possesses qualities of high abrasion resistance and extremely low surface friction which enables easy casting and creates fast sink rates

Length (m)	Diameter (mm)	Breaking Strain (kg)
150	0,14	2,21
150	0,16	2,77
150	0,18	3,31
150	0,20	4,10
150	0,23	5,23
500	0,16	2,77
500	0,18	3,31
500	0,20	4,10
500	0,23	5,23



Unique and individual innovation made by Cralusso is the **QSP system**, which one helps to reach the optimum line filling. With this solution can avoid the multi-winding and for the reel be over or underfilled. For the **QSP system** labeled lines you can find measuring plates attached which ones support the precise loading of the reel. The QSP downloadable as an application from Google Play and App Store.

1

Please, measure the diameter and height of the spool!

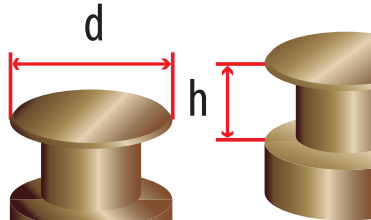

2

Please apply the measurements into the calculator that you will find on our webpage!



3

Select the appropriate value from the indicator and wind the stated amount onto the spool!



4

When you have wound the indicated amount of line onto the reel, it should be at the optimal level!

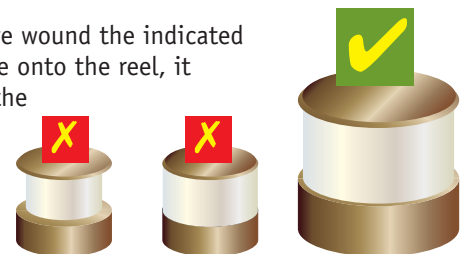

Cralusso lines = Cralusso quality!

QSP SYSTEM

**FEEDER Energy**

2063



This line is recommended for feeder fishing. It is very resilient and has a medium sink rate. The super low friction surface ensures fast movement through the water and positive contact with the fish

Length (m)	Diameter (mm)	Breaking Strain (kg)
150	0,18	4,4
150	0,20	5,5
150	0,22	6,9
150	0,25	8,6
150	0,30	11,8

**METHOD FEEDER SINKING**

2072

2073

QSP SYSTEM

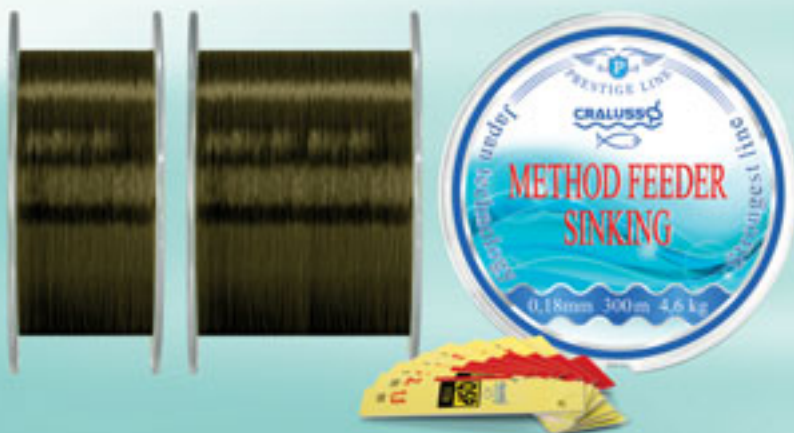

Premium quality fishing line. This high-tech copolymer fishing line produced the best results in our tests. It is a very strong, fast-sinking line with low extensibility, which, thanks to its special low-friction coating, enables 10% longer casts and an extended lifetime.

Length (m)	Diameter (mm)	Test (Kg)
300	0,18	4,6
300	0,20	5,8
300	0,22	6,9
300	0,25	8,8

Length (m)	Diameter (mm)	Test (Kg)
600	0,18	4,6
600	0,20	5,8
600	0,22	6,9
600	0,25	8,8

**CARP Power**

2075

2076

300 m

600 m



Length (m)	Diameter (mm)	Test (Kg)
300	0,22	6,7
300	0,25	8,5
300	0,30	11,8
300	0,35	16,3

Length (m)	Diameter (mm)	Test (Kg)
600	0,22	6,7
600	0,25	8,5
600	0,30	11,8
600	0,35	16,3



# FLUO LINE

QSP SYSTEM

2065

2066



150 m 350 m

A reliable fishing line with high tensile strength. UV and abrasion resistant. The extraordinary smooth surface ensures effortless long range casting.

Length (m)	Diameter (mm)	Breaking Strain (kg)
150	0,18	4,4
150	0,20	5,5
150	0,22	6,9
150	0,25	8,6
150	0,30	11,8

Length (m)	Diameter (mm)	Breaking Strain (kg)
350	0,18	4,4
350	0,20	5,5
350	0,22	6,9
350	0,25	8,6
350	0,30	11,8

# FEEDER & CARP

2095

2096

150 m

300 m



This low-stretch line specially developed for feeder and carp fishing. The fluoro carbon coating guarantee longer casting distance and faster sinking.

Length (m)	Diameter(mm)	Test (Kg)	Fish test (Kg)
150	0,18	2,8	5,1
150	0,20	3,4	6,5
150	0,22	4,0	7,3
150	0,25	5,1	9,5
150	0,30	7,2	13,0

300	0,18	2,8	5,1
300	0,20	3,4	6,5
300	0,22	4,0	7,3
300	0,25	5,1	9,5
300	0,30	7,2	13,0

# Infinity

2071



This line is recommended for feeder and carp fishing. It has a medium sink rate, high abrasion resistance and very low surface friction that assists with long range casting and minimal damage.

Length (m)	Diameter (mm)	Breaking Strain (kg)
500	0,20	5,1
500	0,22	6,5
500	0,25	8,2
500	0,30	11,2

Cralusso lines = Cralusso quality!

# DOMINATOR X8

2067



Fine-woven, quiet, moderately soft-braided fishing line with high tensile strength, wear-resistant surface and zero elongation. Thanks to its thin, special coating, it slides quietly and easily between the rings. Thus, it allows longer casts for spinning anglers even with lighter baits.

Length (m)	Diameter (mm)	Breaking Strain (kg)
100	0,10	5,8
100	0,12	6,9
100	0,15	8,7
100	0,18	11,4
100	0,20	14,2

# NAVIGATOR



Cralusso latest development, NAVIGATOR line family



Feeder Energy (200m) with QSP  
2077



The Navigator Feeder fishing line provides great opportunities for both carp and feeder anglers. Short and long range distances, features and clipping up points are easily identified and there is no problem if you use two or more rods. The line is marked every 5m and this will assist you to fish accurately at the same distance. Please look at the diagram and further information can be found on our webpage. This line was developed in accordance with the requirements of high profile carp and feeder anglers - it is extremely strong, has a medium sink rate, possesses high tensile strength with low stretch and is an easily managed.

**THE SOLUTION: The QSP system** which is only provided by Cralusso! It will help to avoid the need for multiple attempts at filling spools accurately. You will find the description on page 30 and further information on our webpage.

QSP QR CODE



Length (m)	Diameter (mm)	Breaking Strain (kg)
200	0,18	4,40
200	0,20	5,51
200	0,22	6,90
200	0,25	8,60

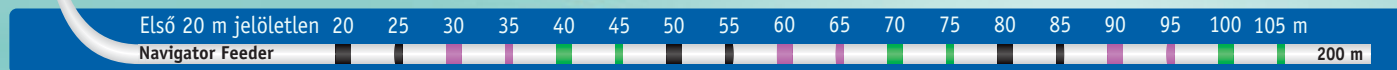

# Fluoro Carbon Line

2090



Fluoro carbon is being nearly invisible in water and this 100% fluoro carbon exceeds all expectations. It has a low stretch and fast sinking rate.

Length (m)	Diameter (mm)	Breaking Strain (kg)
30+10	0,14	1,92
30+10	0,16	2,52
30+10	0,18	3,09
30+10	0,20	3,90
30+10	0,22	5,06
30+10	0,25	6,12
30+10	0,30	7,55
30+10	0,40	14,55
30+10	0,50	20,24



**NEW**

## Big Fish Pro Line

2092



Fishing line developed for catching big fish, whether it's a predator or a silver carp, it withstands extreme conditions. This colorless fishing line can also be used as hooklength line, thanks to its high tensile strength, knot resistance, and resistance to surface damage. Suitable for both freshwater and saltwater fishing.

Length (m)	Diameter (mm)	Test (Kg)
300	0,50	21,7
300	0,60	30,5
250	0,70	39,6

## CARPower feederGUM

2098



Recommend to the following line thicknesses:

Length (m)	Diameter (mm)	Monofil	Braided (mm)
10	0,65	0,12-0,18	0,06-0,10
10	0,80	0,18-0,25	0,10-0,16
10	1,00	0,25-0,35	0,16-0,22



# Hooks

## Sode Light

2401



Flatted – Forged – Round  
Slim stemmed easy hook



Size	18	16	14	12	10	8	6	4	2
<i>Hooklength</i> <i>Line</i> <small>Soft &amp; Strong</small>	0,10-0,11	0,11-0,12	0,12	0,13	0,14	0,14	0,16	0,18	0,20
Weight (gr)	0,004	0,005	0,008	0,012	0,017	0,023	0,05	0,09	0,12
Diameter (mm)	0,27	0,28	0,33	0,37	0,41	0,49	0,57	0,72	0,76
Pcs/bag	14	14	16	16	16	16	14	14	14



## Chika

2405



Flatted – Round



Size	18	16	15	14	12	10	8
<i>Hooklength</i> <i>Line</i> <small>Soft &amp; Strong</small>	0,10	0,10-0,11	0,12	0,12	0,12-0,13	0,13-0,14	0,14
Weight (gr)	0,005	0,008	0,011	0,014	0,018	0,024	0,029
Diameter (mm)	0,28	0,33	0,36	0,39	0,43	0,46	0,48
Pcs/bag	16	16	16	16	14	14	14



## Koaji Round

2410

## Koaji Round Brass

2411



Flatted – Round



Size	16	14	12	10	8
<i>Hooklength</i> <i>Line</i> <small>Soft &amp; Strong</small>	0,10-0,11	0,12	0,14	0,14-0,15	0,16
Weight (gr)	0,009	0,016	0,023	0,036	0,049
Diameter (mm)	0,33	0,41	0,46	0,54	0,60
Pcs/bag	16	16	14	14	14



## Shin Aji

2415



Flatted – Large Forged



Size	11	9	7	5
<i>Hooklength</i> <i>Line</i> <small>Soft &amp; Strong</small>	0,18	0,20	0,25	0,30
<b>X</b> TREME	0,10	0,12	0,16	0,18
Weight (gr)	0,045	0,066	0,094	0,14
Diameter (mm)	0,57	0,64	0,72	0,81
Pcs/bag	11	10	9	8





# Hooks

## Umi Tango

2420

Flatted – Forged



Size	16	14	12	10	8	6
<i>Hooklength</i> <i>Line</i> <small>Soft &amp; Strong</small>	0,12	0,12-0,14	0,14-0,16	0,16	0,18	0,18-0,20
<b>X</b> XTREME				0,08	0,10	0,10-0,12
Weight (gr)	0,014	0,024	0,034	0,051	0,083	0,103
Diameter (mm)	0,39	0,46	0,51	0,57	0,68	0,72
Pcs/bag	12	12	12	12	11	10



## SB Chinu

2430

Double (one normal and one micro) edge point  
– Flatted – Forged and Curved



Size	10	8	6	4	2
<i>Hooklength</i> <i>Line</i> <small>Soft &amp; Strong</small>	0,20	0,22	0,25	0,30	0,32-0,35
<b>X</b> XTREME	0,12-0,14	0,14	0,16	0,18	
Weight (gr)	0,049	0,061	0,077	0,134	0,2
Diameter (mm)	0,6	0,68	0,72	0,86	0,99
Pcs/bag	10	10	9	9	7



## Delta Chinu

2435

Triple edge point – Trust Grip – Forged and Curved

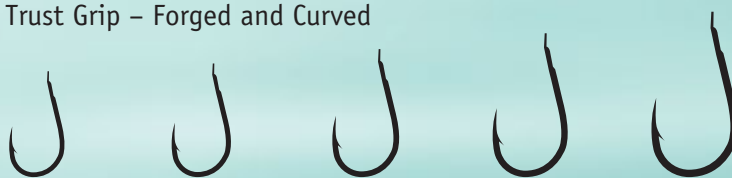

Size	10	8	6	4	2
<i>Hooklength</i> <i>Line</i> <small>Soft &amp; Strong</small>	0,18	0,20	0,22-0,25	0,25-0,30	0,30-0,35
<b>X</b> XTREME	0,10	0,12-0,14	0,14-0,16	0,16-0,18	
Weight (gr)	0,048	0,070	0,084	0,137	0,198
Diameter (mm)	0,6	0,68	0,72	0,86	0,99
Pcs/bag	8	8	8	7	6



## Chinu W/Ring

2440

With PTFE coat

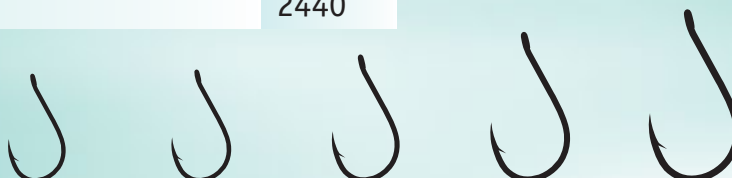

Size	10	8	6	4	2
<i>Hooklength</i> <i>Line</i> <small>Soft &amp; Strong</small>	0,18	0,20	0,22-0,25	0,25-0,30	0,30-0,35
<b>X</b> XTREME	0,10	0,12-0,14	0,14-0,16	0,16-0,18	0,18
Weight (gr)	0,063	0,082	0,10	0,15	0,23
Diameter (mm)	0,6	0,68	0,72	0,86	0,99
Pcs/bag	14	14	13	12	10





# Hooks

## Chinu

2445

Brass



Size	12	11	10	8	6
<i>Hooklength Line</i> <small>Soft &amp; Strong</small>	0,18	0,20	0,22-0,25	0,25-0,30	0,30-0,35
<del>XTREME</del>	0,10	0,12-0,14	0,14-0,16	0,16-0,18	0,18
Weight (gr)	0,031	0,039	0,048	0,066	0,079
Diameter (mm)	0,6	0,68	0,72	0,86	0,99
Pcs/bag	14	14	14	14	14



## Method

2446

Brass



Size	12	10	8	6
<i>Hooklength Line</i> <small>Soft &amp; Strong</small>	0,20	0,22	0,25	0,30
<del>XTREME</del>	0,14	0,16	0,18	0,18
Weight (gr)	0,032	0,056	0,079	0,092
Diameter (mm)	0,6	0,70	0,78	0,89
Pcs/bag	10	10	10	10



## Method Barbless

2447

Brass



Size	12	10	8	6
<i>Hooklength Line</i> <small>Soft &amp; Strong</small>	0,20	0,22	0,25	0,30
<del>XTREME</del>	0,14	0,16	0,18	0,18
Weight (gr)	0,032	0,056	0,079	0,092
Diameter (mm)	0,6	0,70	0,78	0,89
Pcs/bag	10	10	10	10



## Maruseigo

2450

With PTFE coat



Size	14	12	10	8	6	4	2
<i>Hooklength Line</i> <small>Soft &amp; Strong</small>	0,20	0,22	0,28	0,35	0,40	0,40	0,45
<del>XTREME</del>	0,12-0,14	0,14	0,16-0,18				
Weight (gr)	0,031	0,048	0,071	0,104	0,156	0,236	0,367
Diameter (mm)	0,6	0,68	0,72	0,86	0,99	1,06	1,13
Pcs/bag	12	11	11	10	9	8	7



## Gripper Carp

2455

With PTFE coat

Size	8	6	4
Recommended max. line strength	18 lb	20 lb	22 lb
Weight (gr)	0,18	0,24	0,29
Diameter (mm)	0,94	0,98	1,10
Pcs/bag	8	8	8





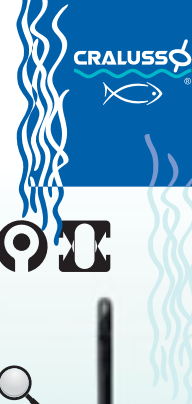

# Hooks

## Boilie Carp

2460

With PTFE coat

Size	8	6	4
Recommended max. line strength	17 lb	24 lb	30 lb
Weight (gr)	0,092	0,145	0,224
Diameter (mm)	0,78	0,89	1,03
Pcs/bag	8	8	8



## Anti Snag

2465

With PTFE coat

Size	8	6	4	2
Recommended max. line strength	18 lb	23 lb	34 lb	37 lb
Weight (gr)	0,17	0,22	0,37	0,40
Diameter (mm)	0,98	1,03	1,22	1,26
Pcs/bag	8	8	8	8



## CARPower

2470

With PTFE coat



Size	14	12	10	8	6	4	2
Recommended max. Monofil line	0,20	0,22	0,25	0,28	0,32	0,35	0,38
Recommended max. braided line	0,12	0,14	0,16	0,18	0,20	0,20	0,22
Weight (gr)	0,028	0,03	0,043	0,054	0,092	0,131	0,23
Diameter (mm)	0,48	0,52	0,62	0,75	0,85	0,951	1,06
Pcs/bag	12	12	12	12	12	12	10



## CARpmagnet Barbless

2472

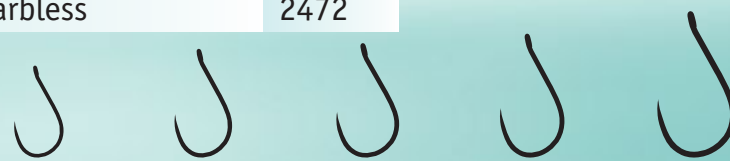

Size	12	10	8	6	4
<i>Hooklength Line</i> Soft & Strong	0,22	0,25	0,28	0,30	0,35
<del>XTREME</del>	0,14	0,16	0,18	0,2	0,22
Weight (gr)	0,049	0,075	0,093	0,107	0,167
Diameter (mm)	0,64	0,72	0,76	0,81	0,92
Pcs/bag	12	12	12	12	12



## Zander-worm

2480



Size	2	1	1/0	2/0
Weight (gr)	0,219	0,272	0,338	0,439
Diameter (mm)	0,86	0,92	0,99	1,07
Pcs/bag	8	8	8	8





# Quality swivels and accessories at a reasonable price!

Rolling swivel, black

2109

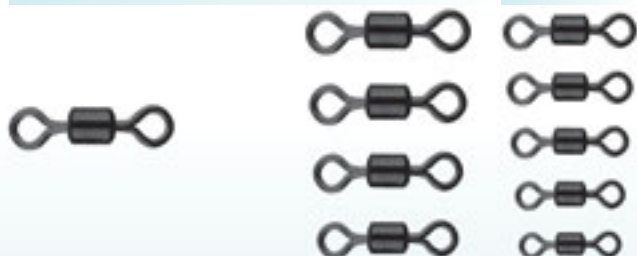

Size	Test	Weight	Pcs/bag
3/0	100 kg	1,82 gr	3 pcs
2/0	75 kg	1,28 gr	4 pcs
1/0	60 kg	0,90 gr	5 pcs
2	43 kg	0,53 gr	6 pcs
4	35 kg	0,33 gr	8 pcs
6	30 kg	0,19 gr	12 pcs
8	19 kg	0,12 gr	12 pcs
10	14 kg	0,07 gr	12 pcs
12	9 kg	0,06 gr	12 pcs

Golden swivel

2110

Exclusive design



Size	Test	Weight	Pcs/bag
3	40 kg	0,41 gr	10 pcs
5	32 kg	0,25 gr	12 pcs
7	22 kg	0,13 gr	12 pcs
10	14 kg	0,07 gr	12 pcs
14	4 kg	0,04 gr	12 pcs

Rhombus swivel

2111



Size	Test	Weight	Pcs/bag
5	27 kg	0,25 gr	12 pcs
7	19 kg	0,13 gr	12 pcs
10	9 kg	0,07 gr	12 pcs
12	6 kg	0,06 gr	12 pcs
14	4 kg	0,04 gr	12 pcs

Double swivel

2112



Size	Test	Weight	Pcs/bag
5	32 kg	0,44 gr	12 pcs
7	22 kg	0,25 gr	12 pcs
10	14 kg	0,13 gr	12 pcs
12	8 kg	0,09 gr	12 pcs
14	4 kg	0,06 gr	12 pcs

Triple speed swivel

2113



Size	Test	Weight	Pcs/bag
7	22 kg	0,23 gr	12 pcs
10	14 kg	0,112 gr	12 pcs
12	8 kg	0,10 gr	12 pcs
14	4 kg	0,062 gr	12 pcs

Triple chain swivel

2114

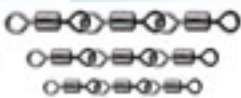

Size	Test	Weight	Pcs/bag
7	22 kg	0,23 gr	12 pcs
10	14 kg	0,112 gr	12 pcs
14	4 kg	0,062 gr	12 pcs

Swivel & safety snap

2115



Size	Test	Weight	Pcs/bag
5	9 kg	0,40 gr	12 pcs
7	7 kg	0,23 gr	12 pcs
10	5 kg	0,14 gr	12 pcs
14	3 kg	0,10 gr	12 pcs

Crane swivel with interlock snap

2116

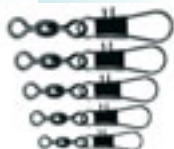

Size	Test	Weight	Pcs/bag
2	18 kg	0,52 gr	10 pcs
4	14 kg	0,38 gr	12 pcs
6	12 kg	0,26 gr	12 pcs
8	10 kg	0,16 gr	12 pcs
10	9 kg	0,12 gr	12 pcs

Double rolling swivel with interlock snap

2150



Size	Test	Weight	Pcs/bag
6	12 kg	0,43 gr	6 pcs
8	10 kg	0,26 gr	6 pcs
10	10 kg	0,20 gr	6 pcs
12	7 kg	0,15 gr	6 pcs



# Quality swivels and accessories at a reasonable price!

Swivel with hooked snap

2117



Size	Test	Weight	Pcs/bag
5	28 kg	0,55 gr	12 pcs
7	20 kg	0,25 gr	12 pcs
10	12 kg	0,13 gr	12 pcs
14	4 kg	0,06 gr	12 pcs

Ball bearing swivel with snap

2118



Size	Test	Weight	Pcs/bag
0	12 kg	0,32 gr	6 pcs
1	18 kg	0,52 gr	6 pcs
2	25 kg	0,76 gr	6 pcs
4	35 kg	1,60 gr	6 pcs

Swing coastlock snap

2119



Size	Test	Weight	Pcs/bag
6	30 kg	0,32 gr	12 pcs
8	19 kg	0,20 gr	12 pcs
10	14 kg	0,12 gr	12 pcs
12	9 kg	0,08 gr	12 pcs

Side-line rolling swivel

2120



Size	Test	Weight	Pcs/bag
2	43 kg	0,88 gr	6 pcs
4	35 kg	0,56 gr	6 pcs
6	30 kg	0,32 gr	6 pcs
8	19 kg	0,18 gr	6 pcs

Corner plate swivel

2121

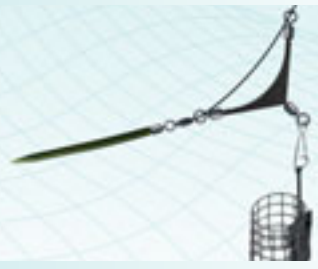

Size	Weight	Pcs/bag
6	1,3 gr	3 pcs
8	0,94 gr	3 pcs
10	0,57 gr	3 pcs

Brass Head Safety Snap

2122



Size	Weight	Pcs/bag
S	0,17 gr	6 pcs
M	0,26 gr	6 pcs

Plastic head swivel with interlock snap

2123



Size	Weight	Pcs/bag
S	0,15 gr	6 pcs
M	0,23 gr	6 pcs

Self-lock rotating snap

2124



Size	Test	Weight	Pcs/bag
4/0	90 kg	3,50 gr	4 pcs
2/0	70 kg	1,84 gr	6 pcs
1	55 kg	1,06 gr	10 pcs
3	40 kg	0,67 gr	10 pcs
5	30 kg	0,43 gr	12 pcs
7	15 kg	0,24 gr	12 pcs
10	10 kg	0,14 gr	12 pcs

Hooked snap

2125



Size	Test	Weight	Pcs/bag
00	9 kg	0,03 gr	12 pcs
0	12 kg	0,04 gr	12 pcs
1	20 kg	0,08 gr	12 pcs
2	28 kg	0,13 gr	12 pcs
3	35 kg	0,20 gr	12 pcs



# Quality swivels and accessories at a reasonable price!

Rolling swivel with nice snap

2127



Size	Test	Weight	Pcs/bag
4/0	70 kg	2,05 gr	4 pcs
2/0	44 kg	1,45 gr	6 pcs
1	38 kg	0,92 gr	10 pcs
3	33 kg	0,68 gr	12 pcs
5	27 kg	0,44 gr	12 pcs
7	20 kg	0,27 gr	12 pcs
10	12 kg	0,13 gr	12 pcs

Quick snap with fixing tube

2128



Size	Pcs/bag
6	6 pcs
8	6 pcs



Safety lead snap kit

2130

2x6 pcs/bag



Swivel with pearl beads and rubber stopper

2129

Size	Pcs/bag
M	2x4 pcs



Slipping feeder fixing set

2131

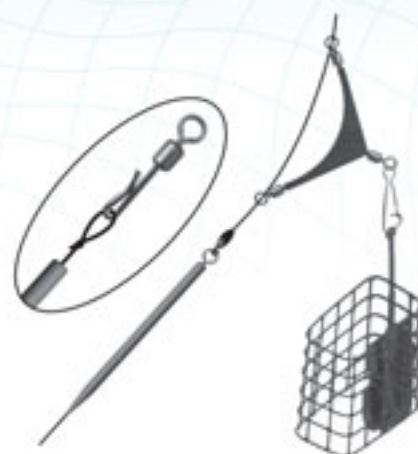
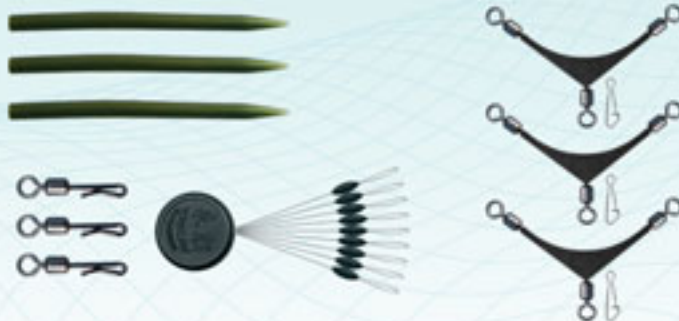



# Quality swivels and accessories at a reasonable price!

## Match Quick snap

2132



Size	Pcs/bag
8	6 pcs
10	6 pcs
12	6 pcs
14	6 pcs



## Swivel with side line clip

2135



Size	Test	Weight	Pcs/bag
8	14 kg	0,20 gr	12 pcs
10	9 kg	0,12 gr	12 pcs
12	4 kg	0,08 gr	12 pcs

## Rolling quick snap

2134



Size	Test	Weight	Pcs/bag
8	9 kg	0,16 gr	6 db
10	7 kg	0,1 gr	6 db
12	5 kg	0,06 gr	6 db
14	3 kg	0,04 gr	6 db

## Double quick snap swivel

2136



Size	Test	Weight	Pcs/bag
8	9 kg	0,24 gr	6 db
10	7 kg	0,15 gr	6 db
12	5 kg	0,1 gr	6 db
14	3 kg	0,06 gr	6 db

## Feeder quick snap

2133



M 6 pcs/bag

## Not-A-Knot swivel

2146



XXL 40 kg 6 pcs/bag

## Soft beads

2141

1,2x6mm  
8 pcs/bag



## Maggot clips

2145

11x14x0,5 mm  
6 pcs/bag



## Method power quick snap

2137

Most powerful method snap



Size	Test	Weight	Pcs/bag
8	9 kg	0,36 gr	6 db

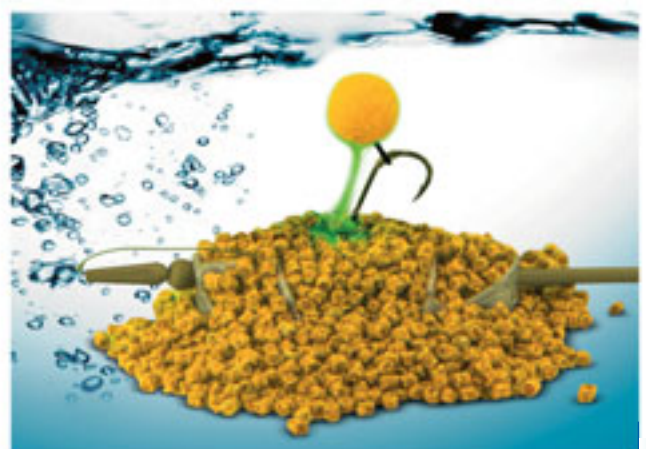



## Pop up, Suspended, solvable and smoking mini boilies



Code	Size	Weight	Flavor
2600	8 mm	20 gr	Pineapple
2605	8 mm	20 gr	Strawberry
2606	8 mm	20 gr	Chocolate-mango
2620	8×12 mm	20 gr	Pineapple
2625	8×12 mm	20 gr	Strawberry
2626	8×12 mm	20 gr	Chocolate-mango
2640	12 mm	40 gr	Pineapple
2645	12 mm	40 gr	Strawberry

## Pop up, Fluo mini boilie

Code	Size	Weight	Flavor
2665	10 mm	40 gr	Fluo pineapple
2666	10 mm	40 gr	Chocolate-mango
2678	12 mm	40 gr	Fluo pineapple



## Pop up white mini boilie

Code	Size	Weight	Flavor
2680	8 mm	20 gr	Garlic
2685	8 mm	20 gr	N-Butyric acid
2690	12 mm	40 gr	Garlic
2695	12 mm	40 gr	N-Butyric acid





## Balanced wafers mini boilie



Code	Size	Weight	Flavor
2740	6×7 mm	20 gr	Strawberry
2741	6×7 mm	20 gr	Coconut chocolate
2743	6×7 mm	20 gr	Corn
2744	7 mm	20 gr	Chocolate-Orange
2745	7 mm	20 gr	Mango
2749	7×9 mm	20 gr	Coconut chocolate
2750	7×9 mm	20 gr	Pineapple
2751	7×9 mm	20 gr	Strawberry
2752	7×9 mm	20 gr	Garlic
2756	7×9 mm	40 gr	Mango
2753	9×11 mm	40 gr	Fluo pineapple
2754	9×11 mm	40 gr	N-butyric acid
2755	9×11 mm	40 gr	Mango
2757	9×11 mm	40 gr	Coconut chocolate

## Ready to go mini boilie



Code	Size	Weight	Flavor
2760	8 mm	20 gr	Pineapple - Pop up
2761	8 mm	20 gr	Garlic - Pop up
2762	7×9 mm	20 gr	Mango - Wafers
2766	7×9 mm	20 gr	Coconut chocolate
2764	9×11 mm	40 gr	Corn - Balanced
2765	9×11 mm	40 gr	Mango - Wafers
2767	12 mm	40 gr	Fluo pineapple - Pop up

No need to bother anymore with mounting, just hang up the balanced hooklength into the method snap from the box. The hook and the bait size, thickness of hooklength and balance lead harmonize with each other what is one of the main part of successful fishing. Contains one prepared hooklength per box.







# Award-winning environmentally friendly, degradable hook baits.

## Jelly Corn



**NOT PLASTIC!**

Scientists estimate that for conventional plastic corn baits it takes about 500 years to decompose!

**LET'S PROTECT THE ENVIRONMENT AND FISH!**

Baits made from food-grade raw materials.

Developed from materials tested by the Department of Aquaculture at Szent István University, new generation flexible hook baits are digestible for fish. The box contains several sizes of natural-shaped corn, shell snail baits that are flavored, capable of absorbing and releasing aroma and color. They can be used on hooks, bait spikes or boilie stoppers. After use, close the boxes as the material can dry out, but when placed in water, aroma or brandy, they swell again.

Code	Colour	Flavor	Pcs/bag
2505	yellow	Pineapple	30 pcs
2506	red	Strawberry	30 pcs
2507	orange	chocolate-orange	30 pcs
2519	yellow	Mango	30 pcs
2520	white	N-butyric acid	30 pcs
2522	yellowish green	Garlic	30 pcs
2523	green	brandy corn	30 pcs
2524	brown	hazelnut	30 pcs

## Jelly Shell



**NOT PLASTIC Full natural!**

Code	Colour	Flavor	Pcs/bag
2530	white	shell	30 pcs
2531	yellow	vanilla	30 pcs
2532	red	anise	30 pcs
2533	orange	chocolate-orange	30 pcs
2534	yellow	pineapple	30 pcs
2535	green	garlic	30 pcs
2536	brown	hazelnut	30 pcs

## Jelly Snail



**NOT PLASTIC Full natural!**

Code	Colour	Flavor	Pcs/bag
2540	yellow	pineapple	30 pcs
2541	red	strawberry	30 pcs
2542	orange	mango	30 pcs
2543	brown	cocoa	30 pcs
2544	white	N-butyric acid	30 pcs
2545	yellowish green	garlic	30 pcs
2546	brown	hazelnut	30 pcs

## Jelly Leech – Catfish bait



**NOT PLASTIC Full natural!**

Code	Flavor	Pcs/bag
2550	fish	12 pcs
2551	liver	12 pcs
2552	shell	12 pcs



# FISHING MASTER

Aroma spray

Code	Flavor	L. measure
2850	Fluo pineapple	50 ml
2855	Strawberry	50 ml
2865	Garlic	50 ml
2871	Mango	50 ml
2875	Squid, octopus	50 ml

NEW

Code	Flavor	L. measure
2890	Shell	50 ml
2891	Fish	50 ml
2892	Liver	50 ml

NEW

NEW

NEW



# FISHING MASTER

Method gel

Code	Flavor	Weight
2880	Fluo pineapple	100 gr
2881	Strawberry	100 gr
2883	Garlic	100 gr
2884	Fluo squid octopus	100 gr
2885	Mango	100 gr



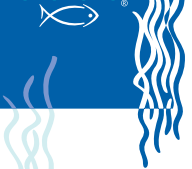

# Tripod

Tripod, telescopic  
Stainless steel



3525

Adjustable tripod set  
Stainless steel



3526

# Telescopic bankstick

Stainless steel  
telescopic bankstick



85-135cm

3542

Stainless steel  
telescopic buzz bar



30-45cm

3540



30-50cm

3590



# Feeder rod rest

3670

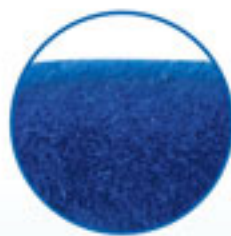

Unique, velvety protective surface

3671



3675



Method rod rest "M"

3676



Method rod rest "L"

# Rod rest

3631



3650



3655



3660



# Feeder Basket

## Method basket plated

(packing bag)

3205



LEAD FREE

Code	Weight	Pcs/bag
3205-20	20 gr	2 pcs
3205-25	25 gr	2 pcs
3205-30	30 gr	2 pcs

## Method basket stemmed

(packing bag)

3210



LEAD FREE

Code	Weight	Pcs/bag
3210-20	20 gr	2 pcs
3210-25	25 gr	2 pcs
3210-30	30 gr	2 pcs

## Eco method basket set

3250

Set:

- EXC method feeder 20 g – 1 pcs
- EXC method feeder 30 g – 1 pcs
- EXC method modul – 1 pcs
- Rolling swivel 10 – 2 pcs

## Aerowinged basket

(packing bag)

3280



LEAD FREE

Code	Weight	Pcs/bag
3280-20	20 gr	2 pcs





# Feeder Basket

Protected product!

Pop-up feeder basket fix

3295



Pop-up feeder basket adjustable

3296

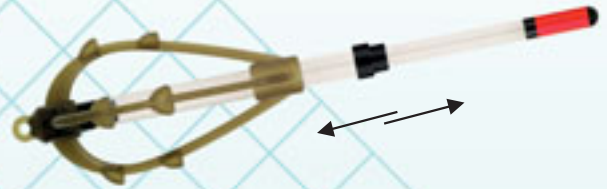

The pop-up feeder basket weighs only 2 grams. Filled with feed, it sinks to the bottom and stays there until much of the feed is dissolved. Thereafter, its light buoyancy brings it slowly towards the surface, 'scanning' through the entire water column. Takes may be expected in multiple phases, either in midwater, with the bait sinking slowly together with the basket, or lying on the bottom, but often it is the bait rising up to midwater that triggers an intensive take. The speed of sinking or rising can be controlled thanks to the adjustable design.

Zero Weightless Feeder basket

3297



Slow Sinking Method basket 15 gr 3298

For midwater fishing  
Watch the YouTube video!



Slow Sinking Method basket + charger 3299



## New generation method baskets and fillers

A unique innovation: patented Cralusso method baskets with longitudinal ribs. Thanks to its special design the hook is less likely to become attached to the longitudinal ribs and it perfectly retains the feed as long as necessary and quickly releases it in the water. With its centre of gravity close to its front end it is particularly suitable for long and accurate throws. You can replace your feeder basket with one of a different size simply and quickly, without having to take apart your tackle.

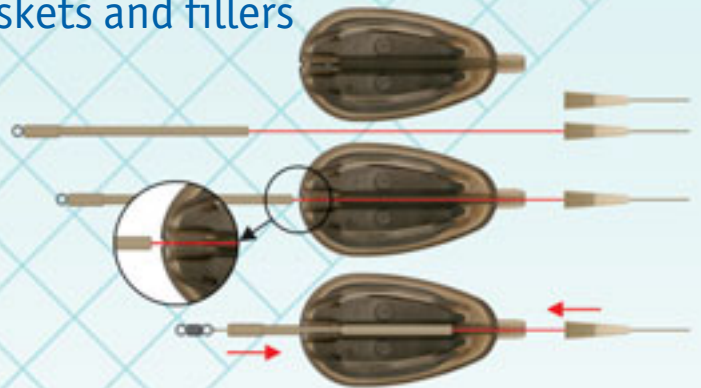

Sensitive method basket

3300



Code	Weight	Pcs/bag
3300-30	30 gr	1 pcs
3300-40	40 gr	1 pcs
3300-50	50 gr	1 pcs
3300-60	60 gr	1 pcs
3300-70	70 gr	1 pcs

NEW



# Feeder baskets



Rocket method basket

3305



NEW

Code	Weight	Pcs/bag
3305-30	30 gr	1 pcs
3305-40	40 gr	1 pcs
3305-50	50 gr	1 pcs
3305-60	60 gr	1 pcs
3305-70	70 gr	1 pcs

Fluo Green Rocket Method basket

3306

Plastic-free packaging



Code	Weight	
3306-30	30 gr	Fluo Green Rocket Method basket
3306-40	40 gr	Fluo Green Rocket Method basket
3306-50	50 gr	Fluo Green Rocket Method basket
3306-60	60 gr	Fluo Green Rocket Method basket

Orange Rocket Method basket

3307

Plastic-free packaging

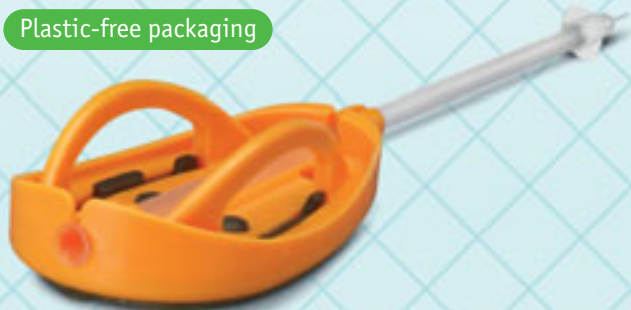

Code	Weight	
3307-30	30 gr	Orange Rocket Method basket
3307-40	40 gr	Orange Rocket Method basket
3307-50	50 gr	Orange Rocket Method basket
3307-60	60 gr	Orange Rocket Method basket

Pink Rocket Method basket

3308

Plastic-free packaging



Code	Weight	
3308-30	30 gr	Pink Rocket Method basket
3308-40	40 gr	Pink Rocket Method basket
3308-50	50 gr	Pink Rocket Method basket
3308-60	60 gr	Pink Rocket Method basket

Crystal Rocket Method basket

3309

Plastic-free packaging



Code	Weight	
3309-30	30 gr	Crystal Rocket Method basket
3309-40	40 gr	Crystal Rocket Method basket
3309-50	50 gr	Crystal Rocket Method basket
3309-60	60 gr	Crystal Rocket Method basket

Method basket stem set

5 pcs/bag

3345





# DOUBLE CHANCE method, a unique Innovation for catching more fish!

Duble Chance Method basket

3315

Code	Weight	Pcs/bag
3315-30	30 gr	1 pcs
3315-40	40 gr	1 pcs
3315-50	50 gr	1 pcs
3315-70	70 gr	1 pcs



The Double Chance Method basket is Cralusso's latest, unique development. Use the newly developed basket for even more successful fishing! Two baits, of different flavours and buoyancies can be presented simultaneously to find the day's winner bait. When you pull out your rig after an unfinished or a missed take and check the hooklength (long one, see the drawing), you'll see which bait attracted the fish. While playing a hooked fish the other hook safely retracts into the basket tube – to keep the fish from being harmed and avoid getting the hook caught in rocks or vegetation in the water.



## Assembling

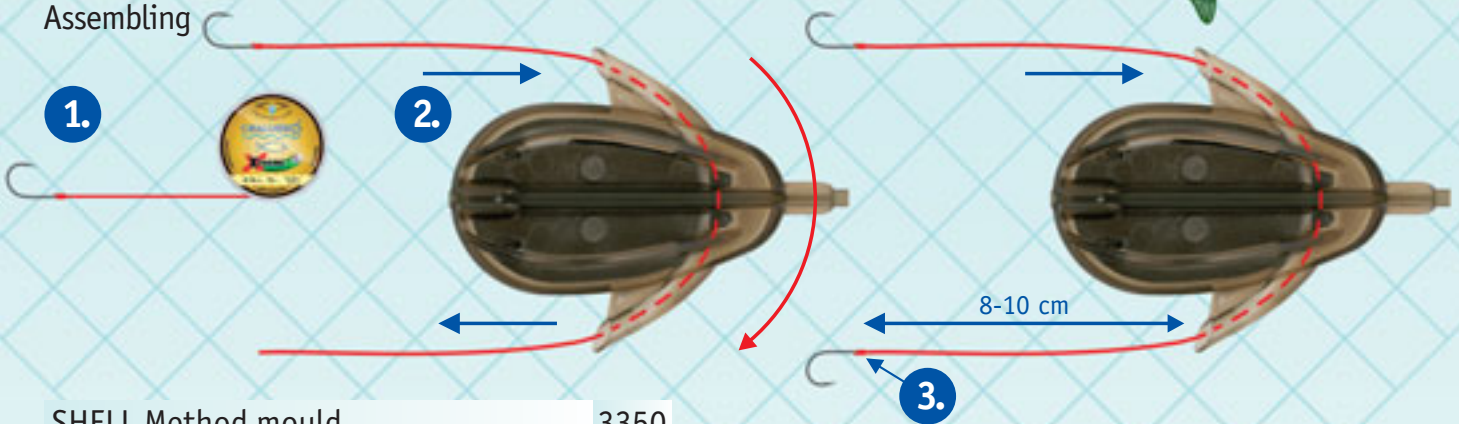

SHELL Method mould

3350



We recommend that you use 3350 Blue Shell Method filling device for filling Double Chance feeder baskets. The gaps on the side of the openable device accommodate the two lateral wings of the Double Chance basket. The Blue Shell method feeder basket filling device provides for simple and quick filling, and the feeding stuff will never stick to it. You simply open the device off the filled basket.





# Method packages

Sensitive package

3360



Code	Weight	Pcs/bag
3360-30	30 gr	2 pcs
3360-40	40 gr	2 pcs
3360-50	50 gr	2 pcs
3360-70	70 gr	2 pcs

Double Chance Method basket package

3375



Code	Weight	Pcs/bag
3375-30	30 gr	2 pcs
3375-40	40 gr	2 pcs
3375-50	50 gr	2 pcs
3375-70	70 gr	2 pcs

Rocket package

3365



Code	Weight	Pcs/bag
3365-30	30 gr	2 pcs
3365-40	40 gr	2 pcs
3365-50	50 gr	2 pcs
3365-70	70 gr	2 pcs





# Method set

Sensitive set

3400



Code	Weight	Pcs/bag
3400-30	30 gr	2+1 pcs
3400-40	40 gr	2+1 pcs
3400-50	50 gr	2+1 pcs
3400-70	70 gr	2+1 pcs

Double Chance Method basket set

3410



Rocket set

3405



Code	Weight	Pcs/bag
3410-30	30 gr	2+1 pcs
3410-40	40 gr	2+1 pcs
3410-50	50 gr	2+1 pcs
3410-70	70 gr	2+1 pcs

Code	Weight	Pcs/bag
3405-30	30 gr	2+1 pcs
3405-40	40 gr	2+1 pcs
3405-50	50 gr	2+1 pcs
3405-60	60 gr	2+1 pcs
3405-70	70 gr	2+1 pcs

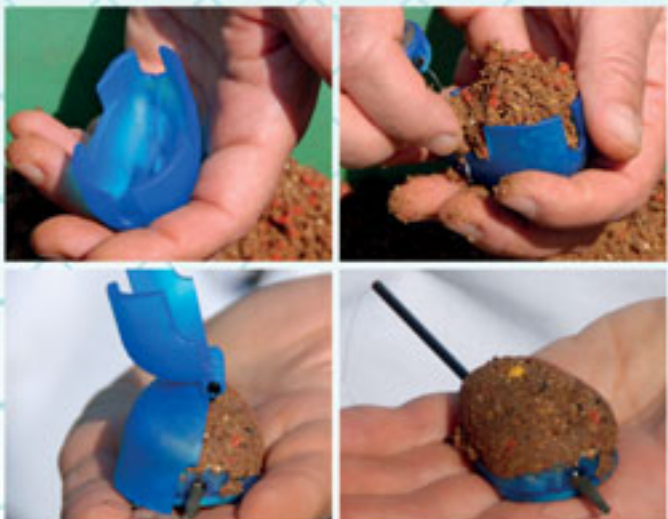

NEW





# Method set



Rocket method set 3420

Code	Weight	
3420-30	30 gr	Fluo green basket + Charger
3420-40	40 gr	Fluo green basket + Charger
3420-50	50 gr	Fluo green basket + Charger
3420-60	60 gr	Fluo green basket + Charger

Plastic-free packaging



Rocket method set 3421

Code	Weight	
3421-30	30 gr	Orange basket + Charger
3421-40	40 gr	Orange basket + Charger
3421-50	50 gr	Orange basket + Charger
3421-60	60 gr	Orange basket + Charger

Plastic-free packaging



Rocket method set 3422

Code	Weight	
3422-30	30 gr	Pink basket + Charger
3422-40	40 gr	Pink basket + Charger
3422-50	50 gr	Pink basket + Charger
3422-60	60 gr	Pink basket + Charger

Plastic-free packaging



Rocket method set 3323

Code	Weight	
3423-30	30 gr	Crystal basket + Charger
3423-40	40 gr	Crystal basket + Charger
3423-50	50 gr	Crystal basket + Charger
3423-60	60 gr	Crystal basket + Charger

Plastic-free packaging



## Big Rocket method bascets



The larger version of the popular Rocket method basket can accommodate 30% larger amount of feed. It is especially important for long-distance fishing and frequently installed waters.

### Big Rocket method basket 3430

Plastic-free packaging



Code	Weight	
3430-30	30 gr	Big Rocket method basket khaki
3430-40	40 gr	Big Rocket method basket khaki
3430-50	50 gr	Big Rocket method basket khaki
3430-70	70 gr	Big Rocket method basket khaki

### Big Rocket method basket 3431

Plastic-free packaging



Code	Weight	
3431-30	30 gr	Big Rocket method basket chrystal
3431-40	40 gr	Big Rocket method basket chrystal
3431-50	50 gr	Big Rocket method basket chrystal
3431-70	70 gr	Big Rocket method basket chrystal

### Big Rocket method basket 3432

Plastic-free packaging



Code	Weight	
3432-30	30 gr	Big Rocket method basket white
3432-40	40 gr	Big Rocket method basket white
3432-50	50 gr	Big Rocket method basket white
3432-70	70 gr	Big Rocket method basket white

### Big Rocket method basket 3436

Plastic-free packaging



Code	Weight	
3436-30	30 gr	Big Rocket method basket fluo green
3436-40	40 gr	Big Rocket method basket fluo green
3436-50	50 gr	Big Rocket method basket fluo green
3436-70	70 gr	Big Rocket method basket fluo green



# Big Rocket method sets



Big Rocket method set 3433

Code	Weight	
3433-30	30 gr	khaki basket + charger
3433-40	40 gr	khaki basket + charger
3433-50	50 gr	khaki basket + charger
3433-70	70 gr	khaki basket + charger

Plastic-free packaging



Big Rocket method set 3434

Code	Weight	
3434-30	30 gr	chrystal basket + charger
3434-40	40 gr	chrystal basket + charger
3434-50	50 gr	chrystal basket + charger
3434-70	70 gr	chrystal basket + charger

Plastic-free packaging



Big Rocket method set 3435

Code	Weight	
3435-30	30 gr	white basket + charger
3435-40	40 gr	white basket + charger
3435-50	50 gr	white basket + charger
3435-70	70 gr	white basket + charger

Plastic-free packaging



Big Rocket method set 3437

Code	Weight	
3434-30	30 gr	fluo green basket + charger
3434-40	40 gr	fluo green basket + charger
3434-50	50 gr	fluo green basket + charger
3434-70	70 gr	fluo green basket + charger

Plastic-free packaging



## Small Rocket method baskets

### Small Rocket method baskets

3440

Plastic-free packaging

Code	Weight	
3440-25	25 gr	khaki Small Rocket method basket
3440-30	30 gr	khaki Small Rocket method basket
3440-40	40 gr	khaki Small Rocket method basket
3440-50	50 gr	khaki Small Rocket method basket



### Small Rocket method baskets

3441

Plastic-free packaging

Code	Weight	
3441-25	25 gr	chrysal Small Rocket method basket
3441-30	30 gr	chrysal Small Rocket method basket
3441-40	40 gr	chrysal Small Rocket method basket
3441-50	50 gr	chrysal Small Rocket method basket



### Small Rocket method baskets

3442

Plastic-free packaging

Code	Weight	
3442-25	25 gr	black Small Rocket method basket
3442-30	30 gr	black Small Rocket method basket
3442-40	40 gr	black Small Rocket method basket
3442-50	50 gr	black Small Rocket method basket

### Small Rocket method set

3445

Code	Weight	
3445-25	25 gr	khaki basket + charger
3445-30	30 gr	khaki basket + charger
3445-40	40 gr	khaki basket + charger
3445-20	50 gr	khaki basket + charger

### Small Rocket method set

3446

Code	Weight	
3446-25	25 gr	chrysal basket + charger
3446-30	30 gr	chrysal basket + charger
3446-40	40 gr	chrysal basket + charger
3446-20	50 gr	chrysal basket + charger

### Small Rocket method set

3447

Code	Weight	
3447-25	25 gr	black basket + charger
3447-30	30 gr	black basket + charger
3447-40	40 gr	black basket + charger
3447-20	50 gr	black basket + charger







# Innovative openable method basket quick-fillers without the nuisance of feeding stuff sticking inside. They can be used for a variety of method feeder baskets

Protected product!

## Blue Shell

3350

Internal size 55x34 mm



Patented method fillers that are simple and quick to use. Recommended for anglers using their filler devices holding them in their hands. In addition to Cralusso's method baskets it is also compatible with the competition-size baskets manufactured by Guru, Drennen, Mivardi, Haldorádó etc.



## Orange Shell

3351

Internal size 55x34 mm



Its shape is the same as that of Blue Shell. This self-locking version is recommended for anglers preferring to use their filler devices laid down. In addition to Cralusso's method baskets it is also compatible with the competition-size baskets manufactured by Guru, Drennen, Mivardi, Haldorádó, Topmix etc.



Self-lock patent version!

## Green Shell

3352

Internal size 49x28 mm



An opening quick-filler manufactured for method baskets of the most frequently used sizes and shapes. It can be effectively used with Preston, Energofish, TopMix, Nevis, Haldorádó etc. baskets. It makes filling baskets easier and quicker.



Self-lock patent version!

## Yellow Shell

3353

Internal size 65x37 mm



An opening quick filler to fill up large method baskets. For easy handling of even such extreme materials as glued maggots. Easy to use with Energofish, Haldorádó and other similarly large baskets.

Shell fillers open up new dimensions in method fishing.

Self-lock patent version!





## Weights



3002



Code	Weight	Pcs/bag
3002-1	1,0 gr	5 pcs
3002-1,5	1,5 gr	5 pcs
3002-2	2,0 gr	5 pcs
3002-2,5	2,5 gr	5 pcs
3002-3	3,0 gr	5 pcs
3002-4	4,0 gr	5 pcs
3002-5	5,0 gr	5 pcs
3002-6	6,0 gr	5 pcs
3002-7	7,0 gr	5 pcs
3002-8	8,0 gr	5 pcs
3002-mix	Mixed	5 pcs

3001



Code	Weight	Pcs/bag
3001-1	1,0 gr	5 pcs
3001-1,5	1,5 gr	5 pcs
3001-2	2,0 gr	5 pcs
3001-2,5	2,5 gr	5 pcs
3001-3	3,0 gr	5 pcs
3001-4	4,0 gr	5 pcs
3001-5	5,0 gr	5 pcs
3001-6	6,0 gr	5 pcs
3001-7	7,0 gr	5 pcs
3001-8	8,0 gr	5 pcs
3001-10	10,0 gr	4 pcs
3001-12	12,0 gr	4 pcs
3001-15	15,0 gr	4 pcs
3001-18	18,0 gr	3 pcs
3001-20	20,0 gr	3 pcs
3001-25	25,0 gr	2 pcs
3001-30	30,0 gr	2 pcs
3001-mix	Mixed	5 pcs

3001-mix



Fix weight without lead, mix

3062



4 pcs/bag

## Anti tangle

Anti tangle tube with strong end 3101

Code	Size	Pcs/bag
3101-30	30 mm	3 pcs
3101-55	55 mm	3 pcs
3101-85	85 mm	3 pcs
3101-120	120 mm	3 pcs



Anti tangle tube with hooked snap 3102

Code	Size	Pcs/bag
3102-80	80 mm	3 pcs
3102-120	120 mm	3 pcs
3102-180	180 mm	3 pcs



Ballancer boom 3110

15 cm



3 pcs/bag

Semi fixed lead ring 3115

25 cm



3 pcs/bag

T-shirt Royal blue and white, Cralusso logo is in front and back, hard-wearing and fine material.

Code: 9002



Caps



Code: 9003



Code: 9004

Fleece sweater embroidered on both sides

Code: 9020

Size:

M - L - XL - XXL





Innovative Fishing Floats and Accessories

2025

CRALUSSO,  
CHOICE OF THE WINNERS

Králik & Tsa. Kkt.  
H-2600 Vác, Zrínyi u. 3.  
Phone: +36/27-304-327  
e-mail:cralusso@cralusso.com

[www.cralusso.com](http://www.cralusso.com)

